



PROPRIETARY NOTE
THIS SPECIFICATION IS THE PROPERTY OF BOE HF AND SHALL NOT BE REPRODUCED OR COPIED WITHOUT THE WRITTEN PERMISSION OF BOE HF AND MUST BE RETURNED TO BOE HF UPON ITS REQUEST

SPEC. NUMBER

PRODUCT GROUP
TFT MODULE

Rev. 0

ISSUE DATE
2012.03.05

PAGE
1 OF30

TITLE : B3 HR215WU1-100

Product Specification

Rev. 0

HEFEI BOE OPTOELECTRONICS TECHNOLOGY



PRODUCT GROUP

REV

ISSUE DATE

PRODUCT SPEC-TFT MODULE

0

2012.03.05

SPEC. NUMBER

SPEC. TITLE

B3 HR215WU1-100 Product Specification_ Rev.0

PAGE

2 OF 30

REVISION HISTORY

REV.	ECN No.	DESCRIPTION OF CHANGES	DATE	PREPARED
0		Initial Release	2012.03.05	Hengzhen Liang



PRODUCT GROUP

REV

ISSUE DATE

PRODUCT SPEC-TFT MODULE

0

2012.03.05

SPEC. NUMBER

SPEC. TITLE

B3 HR215WU1-100 Product Specification_ Rev.0

PAGE

3 OF 30

Contents

No.	Item	Page
1.0	General Description	4
2.0	Absolute Maximum Ratings	6
3.0	Electrical Specifications	7
4.0	Optical Specifications	8
5.0	Interface Connection	10
6.0	Signal Timing Specifications	13
7.0	Signal Timing Waveforms of Interface Signal	15
8.0	Input Signals, Display Colors & Gray Scale of Colors	17
9.0	Power Sequence	18
10.0	Mechanical Characteristics	19
11.0	Reliability Test	20
12.0	Handling& Cautions	21
13.0	Product Serial Number	22
14.0	Packing	23
15.0	Appendix	25

 京东方 BOE	PRODUCT GROUP	REV	ISSUE DATE
	PRODUCT SPEC-TFT MODULE	0	2012.03.05
SPEC. NUMBER	SPEC. TITLE		PAGE
	B3 HR215WU1-100 Product Specification_ Rev.0		4 OF 30

1.0 GENERAL DESCRIPTION

1.1 Introduction

HR215WU1-100 is a color active matrix TFT LCD module using amorphous silicon TFT's (Thin Film Transistors) as an active switching devices. This module has a 21.5 inch diagonally measured active area with FHD resolutions (1920 horizontal by 1080 vertical pixel array). Each pixel is divided into RED, GREEN, BLUE dots which are arranged in vertical stripe and this module can display 16.7M colors. The TFT-LCD panel used for this module is adapted for a low reflection and higher color type.

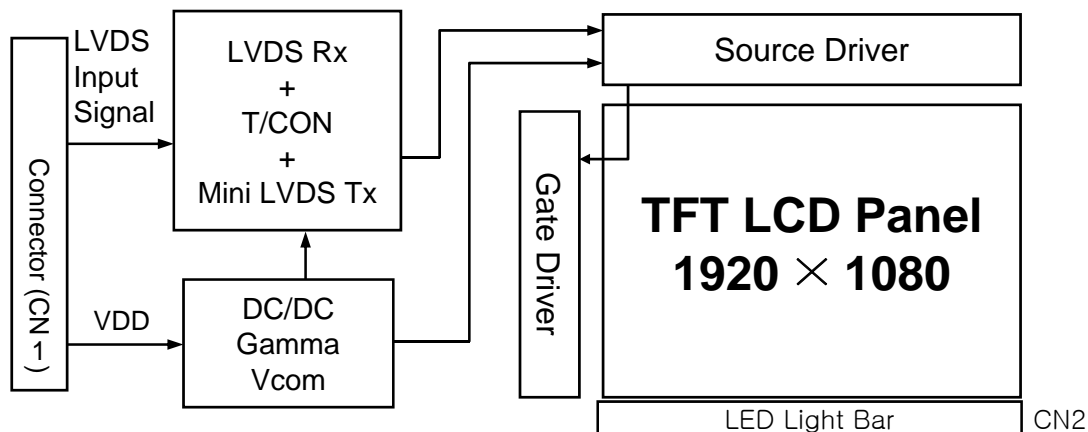

1.2 Features

- LVDS Interface with 2 pixel / clock
- High-speed response
- 6-bit (Hi-FRC) color depth, display 16.7M colors
- Incorporated edge type back-light (One Light Bar)
- High luminance and contrast ratio, low reflection and wide viewing angle
- DE (Data Enable) only
- RoHS /TCO 5.0 ,ES5.0 Compliant

 京东方 BOE	PRODUCT GROUP	REV	ISSUE DATE
	PRODUCT SPEC-TFT MODULE	0	2012.03.05
SPEC. NUMBER	SPEC. TITLE		PAGE
	B3 HR215WU1-100 Product Specification_ Rev.0		5 OF 30

1.3 Application

- Desktop Type of PC & Workstation Use
- Slim-Size Display for Stand-alone Monitor
- Display Terminals for Control System
- Monitors for Process Controller

1.4 General Specification

The followings are general specifications at the model HR215WU1-100.

<Table 1. General Specifications>

Parameter	Specification	Unit	Remarks
Active area	476.64(H) × 268.11 (V)	mm	
Number of pixels	1920(H) × 1080(V)	pixels	
Pixel pitch	0.24825(H) × 0.24825(V)	mm	
Pixel arrangement	RGB Vertical stripe	-	
Display colors	16.7M	colors	
Display mode	Normally Black	-	
Dimensional outline	495.6(H) × 292.2(V) × 10.2(D) typ.	mm	
Weight	1900 (typ.)	g	
Surface Treatment	Anti-glare, 3H	-	
Back-light	Lower side 1-LED Light bar Type	-	

 京东方 BOE	PRODUCT GROUP	REV	ISSUE DATE
	PRODUCT SPEC-TFT MODULE	0	2012.03.05
SPEC. NUMBER	SPEC. TITLE		PAGE
	B3 HR215WU1-100 Product Specification_ Rev.0		6 OF 30

2.0 ABSOLUTE MAXIMUM RATINGS

The followings are maximum values which, if exceed, may cause faulty operation or damage to the unit. The operational and non-operational maximum voltage and current values are listed in Table 2.

< Table 2. Absolute Maximum Ratings > [VSS=GND=0V]

Parameter	Symbol	Min.	Max.	Unit	Remarks
Power Supply Voltage	V_{DD}	-0.5	5.5	V	Ta = 25 °C
Logic Supply Voltage	V_{IN}	VSS-0.3	$V_{DD}+0.3$	V	
Operating Temperature	T_{OP}	0	+50	°C	1)
Storage Temperature	T_{ST}	-20	+60	°C	1)

Note : 1) Temperature and relative humidity range are shown in the figure below.
Wet bulb temperature should be 39 °C max. and no condensation of water.

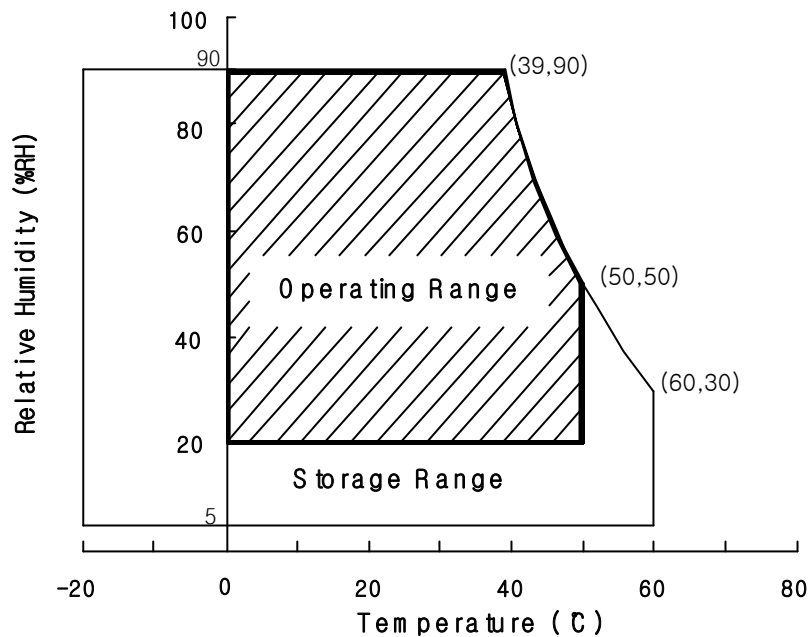

 京东方 BOE	PRODUCT GROUP	REV	ISSUE DATE
	PRODUCT SPEC-TFT MODULE	0	2012.03.05
SPEC. NUMBER	SPEC. TITLE		PAGE
	B3 HR215WU1-100 Product Specification_ Rev.0		7 OF 30

3.0 ELECTRICAL SPECIFICATIONS

3.1 Electrical Specifications

< Table 3. Electrical specifications >

[Ta = 25 ± 2 °C]

Parameter		Min.	Typ.	Max.	Unit	Remarks
Power Supply Voltage	V _{DD}	4.5	5.0	5.5	V	Note 1
Power Supply Current	I _{DD}	-	800	1400	mA	
In-Rush Current	I _{RUSH}	-	-	3	A	Note 2
Permissible Input Ripple Voltage	V _{RF}	-	-	100	mV	V _{DD} = 5.0V
High Level Differential Input Threshold Voltage	V _{IH}	-	-	+100	mV	
Low Level Differential Input Threshold Voltage	V _{IL}	-100	-	-	mV	
Differential input voltage	V _{ID}	200	-	600	mV	
Differential input common mode voltage	V _{cm}	1.0	1.2	1.5		V _{IH} =100mV, V _{IL} =-100mV
LED Voltage	V _L	3.05	3.2	3.5	V	
LED Channel Voltage	V _L	39.65	41.6	45	V	
LED Channel Current	I _L	-	120	160	mA	
LED Lifetime		30,000	-	-	Hrs	I _L =120 mA
Power Consumption	P _D	-	4.9	-	W	
	P _{BL}	-	19.97	-	W	I _L =120 mA, Note 4
	P _{total}	-	24.87	-	W	

Notes : 1. The supply voltage is measured and specified at the interface connector of LCM.

The current draw and power consumption specified is for VDD=5.0V, Frame rate=75Hz. Test Pattern of power supply current

- a) Typ : Color Bar pattern
b) Max : Skip Sub Pixel Pattern

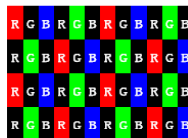

2. Duration of rush current is about 2 ms and rising time of VDD is 520 μs ± 20 %
3. The lamp frequency should be selected as different as possible from the horizontal synchronous frequency and its harmonics to avoid interference, which may cause line flow on the display
4. Calculated value for reference (V_L × I_L) × 4(channel) excluding driver loss. (LED Light bar: 13S4P)

	PRODUCT GROUP	REV	ISSUE DATE
	PRODUCT SPEC-TFT MODULE	0	2012.03.05
SPEC. NUMBER	SPEC. TITLE		PAGE
	B3 HR215WU1-100 Product Specification_ Rev.0		8 OF 30

4.0 OPTICAL SPECIFICATION

4.1 Overview

The test of Optical specifications shall be measured in a dark room (ambient luminance ≤ 1 lux and temperature = $25 \pm 2^\circ\text{C}$) with the equipment of Luminance meter system (Goniometer system and TOPCONE BM-5) and test unit shall be located at an approximate distance 50cm from the LCD surface at a viewing angle of θ and Φ equal to 0° . We refer to $\theta_{0=0}$ ($=\theta_3$) as the 3 o'clock direction (the "right"), $\theta_{0=90}$ ($=\theta_{12}$) as the 12 o'clock direction ("upward"), $\theta_{0=180}$ ($=\theta_9$) as the 9 o'clock direction ("left") and $\theta_{0=270}$ ($=\theta_6$) as the 6 o'clock direction ("bottom"). While scanning θ and/or Φ , the center of the measuring spot on the Display surface shall stay fixed. The measurement shall be executed after 30 minutes warm-up period. VDD shall be 5.0V +/-10% at 25°C . Optimum viewing angle direction is 6 o'clock.

4.2 Optical Specifications

[VDD = 5.0V, Frame rate = 60Hz, Clock = 78MHz, $I_{BL} = 120\text{mA}$, $T_a = 25 \pm 2^\circ\text{C}$]

Parameter		Symbol	Condition	Min.	Typ.	Max.	Unit	Remark
Viewing Angle range	Horizontal	θ_3	CR > 10	-	89	-	Deg.	Note 1
		θ_9		-	89	-	Deg.	
	Vertical	θ_{12}		-	89	-	Deg.	
		θ_6		-	89	-	Deg.	
Viewing Angle range	Horizontal	θ_3	CR > 5	-	89	-	Deg.	
		θ_9		-	89	-	Deg.	
	Vertical	θ_{12}		-	89	-	Deg.	
		θ_6		-	89	-	Deg.	
Luminance Contrast ratio		CR		700	1000	-		Note 2
Luminance of White		Y_w		200	250	-	cd/m ²	Note 3
White luminance uniformity		ΔY		75	80		%	Note 4
Reproduction of color	White	W_x	$\theta = 0^\circ$ (Center) Normal Viewing Angle	0.283	0.313	0.343		Note 5
		W_y		0.299	0.329	0.359		
	Red	R_x		0.617	0.647	0.677		
		R_y		0.309	0.339	0.369		
	Green	G_x		0.277	0.307	0.337		
		G_y		0.603	0.633	0.663		
	Blue	B_x		0.116	0.146	0.176		
		B_y		0.026	0.056	0.086		
Response Time	Rising+Fall ling	T_r+T_f			14		ms	Note 6
Cross Talk		CT		-	-	2.0	%	Note 7

 京东方 BOE	PRODUCT GROUP	REV	ISSUE DATE
	PRODUCT SPEC-TFT MODULE	0	2012.03.05
SPEC. NUMBER	SPEC. TITLE		PAGE
	B3 HR215WU1-100 Product Specification_ Rev.0		9 OF 30

Note :

1. Viewing angle is the angle at which the contrast ratio is greater than 10. The viewing are determined for the horizontal or 3, 9 o'clock direction and the vertical or 6, 12 o'clock direction with respect to the optical axis which is normal to the LCD surface.
2. Contrast measurements shall be made at viewing angle of $\theta=0^\circ$ and at the center of the LCD surface. Luminance shall be measured with all pixels in the view field set first to white, then to the dark (black) state. (See FIGURE 1 shown in Appendix) Luminance Contrast Ratio (CR) is defined mathematically.

$$CR = \frac{\text{Luminance when displaying a white raster}}{\text{Luminance when displaying a black raster}}$$

3. Center Luminance of white is defined as the LCD surface. Luminance shall be measured with all pixels in the view field set first to white. This measurement shall be taken at the locations shown in FIGURE 2 for a total of the measurements per display.
4. The White luminance uniformity on LCD surface is then expressed as :
 $\Delta Y = (\text{Minimum Luminance of 9points} / \text{Maximum Luminance of 9points}) * 100$
(See FIGURE 2 shown in Appendix).
5. The color chromaticity coordinates specified in Table 4. shall be calculated from the spectral data measured with all pixels first in red, green, blue and white. Measurements shall be made at the center of the panel.
6. The electro-optical response time measurements shall be made as FIGURE 3 shown in Appendix by switching the "data" input signal ON and OFF. The times needed for the luminance to change from 10% to 90% is Td, and 90% to 10% is Tr.
7. Cross-Talk of one area of the LCD surface by another shall be measured by comparing the luminance (Y_A) of a 25mm diameter area, with all display pixels set to a gray level, to the luminance (Y_B) of that same area when any adjacent area is driven dark. (See FIGURE 4 shown in Appendix).



PRODUCT GROUP

REV

ISSUE DATE

PRODUCT SPEC-TFT MODULE

0

2012.03.05

SPEC. NUMBER

SPEC. TITLE

PAGE

B3 HR215WU1-100 Product Specification_ Rev.0

10 OF 30

5.0 INTERFACE CONNECTION.

5.1 Electrical Interface Connection

- CN1 Module Side Connector : UJU IS100-L300-C23 or Equivalent
User Side Connector : JAE FI-X30H or Equivalent

Pin No	Symbol	Function	Remark
1	RX00-	Negative Transmission data of Pixel 0 (ODD)	
2	RX00+	Positive Transmission data of Pixel 0 (ODD)	
3	RX01-	Negative Transmission data of Pixel 1 (ODD)	
4	RX01+	Positive Transmission data of Pixel 1 (ODD)	
5	RX02-	Negative Transmission data of Pixel 2 (ODD)	
6	RX02+	Positive Transmission data of Pixel 2 (ODD)	
7	GND	Power Ground	
8	RXOC-	Negative Transmission Clock (ODD)	
9	RXOC+	Positive Transmission Clock (ODD)	
10	RX03-	Negative Transmission data of Pixel 3 (ODD)	
11	RX03+	Positive Transmission data of Pixel 3 (ODD)	
12	RXE0-	Negative Transmission data of Pixel 0 (EVEN)	
13	RXE0+	Positive Transmission data of Pixel 0 (EVEN)	
14	GND	Power Ground	
15	RXE1-	Negative Transmission data of Pixel 1 (EVEN)	
16	RXE1+	Positive Transmission data of Pixel 1 (EVEN)	
17	GND	Power Ground	
18	RXE2-	Negative Transmission data of Pixel 2 (EVEN)	
19	RXE2+	Positive Transmission data of Pixel 2 (EVEN)	
20	RXEC-	Negative Transmission Clock (EVEN)	
21	RXEC+	Positive Transmission Clock (EVEN)	
22	RXE3-	Negative Transmission data of Pixel 3 (EVEN)	
23	RXE3+	Positive Transmission data of Pixel 3 (EVEN)	
24	GND	Power Ground	Note1
25	NC	Not connection, this pin should be open	
26	NC	Not connection, this pin should be open	
27	NC	Not connection	
28	VDD1	Power Supply:+5V	
29	VDD2		
30	VDD3		

Note 1 : This pin should be connected with GND



京东方
BOE

PRODUCT GROUP

REV

ISSUE DATE

PRODUCT SPEC-TFT MODULE

0

2012.03.05

SPEC. NUMBER

SPEC. TITLE

B3 HR215WU1-100 Product Specification_ Rev.0

PAGE

11 OF 30

5.2 LVDS Interface (Tx; THC63LVDF83A or Equivalent)

5.2.1 ODD LVDS Interface

	Input Signal	Transmitter		Interface		HR215WU1-100 (CN11)	Remark
		Pin No.	Pin No.	System (Tx)	TFT-LCD (Rx)	Pin No.	
O D D L V D S	OR0	51	48 47	OUT0- OUT0+	RX00- RX00+	1	
	OR1	52					
	OR2	54					
	OR3	55					
	OR4	56					
	OR5	3					
	OG0	4	46 45	OUT1- OUT1+	RX01- RX01+	3	
	OG1	6					
	OG2	7					
	OG3	11					
	OG4	12					
	OG5	14					
	OB0	15	42 41	OUT2- OUT2+	RX02- RX02+	5	
	OB1	19					
	OB2	20					
	OB3	22					
	OB4	23					
	OB5	24					
	Hsync	27	40 39	CLK OUT- CLK OUT+	RX0 CLK- RX0 CLK+	8 9	
	Vsync	28					
	DE	30	38 37	OUT3- OUT3+	RX03- RX03+	10 11	
	MCLK	31					
	OR6	50					
	OR7	2					
	OG6	8					
OG7	10						
OB6	16	18					
OB7	18						
RSVD	25						



京东方
BOE

PRODUCT GROUP

REV

ISSUE DATE

PRODUCT SPEC-TFT MODULE

0

2012.03.05

SPEC. NUMBER

SPEC. TITLE

B3 HR215WU1-100 Product Specification_ Rev.0

PAGE

12 OF 30

5.2.2 EVEN LVDS Interface

	Input Signal	Transmitter		Interface		HR215WU1-100 (C N11)	Remark
		Pin No.	Pin No.	System (Tx)	TFT-LCD (Rx)	Pin No.	
E V E N L V D S	ER0	51	48 47	OUT0- OUT0+	RXE0- RXE0+	12 13	
	ER1	52					
	ER2	54					
	ER3	55					
	ER4	56					
	ER5	3					
	EG0	4	46 45	OUT1- OUT1+	RXE1- RXE1+	15 16	
	EG1	6					
	EG2	7					
	EG3	11					
	EG4	12					
	EG5	14					
	EB0	15	42 41	OUT2- OUT2+	RXE2- RXE2+	18 19	
	EB1	19					
	EB2	20					
	EB3	22					
	EB4	23					
	EB5	24					
	Hsync	27	40 39	CLK OUT- CLK OUT+	RXE CLK- RXE CLK+	20 21	
	Vsync	28					
	DE	30					
	MCLK	31	38 37	OUT3- OUT3+	RXE3- RXE3+	22 23	
	ER6	50					
	ER7	2					
	EG6	8					
EG7	10						
EB6	16						
EB7	18						
RSVD	25						

 京东方 BOE	PRODUCT GROUP	REV	ISSUE DATE
	PRODUCT SPEC-TFT MODULE	0	2012.03.05
SPEC. NUMBER	SPEC. TITLE		PAGE
	B3 HR215WU1-100 Product Specification_ Rev.0		13 OF 30

5.3 Data Input Format

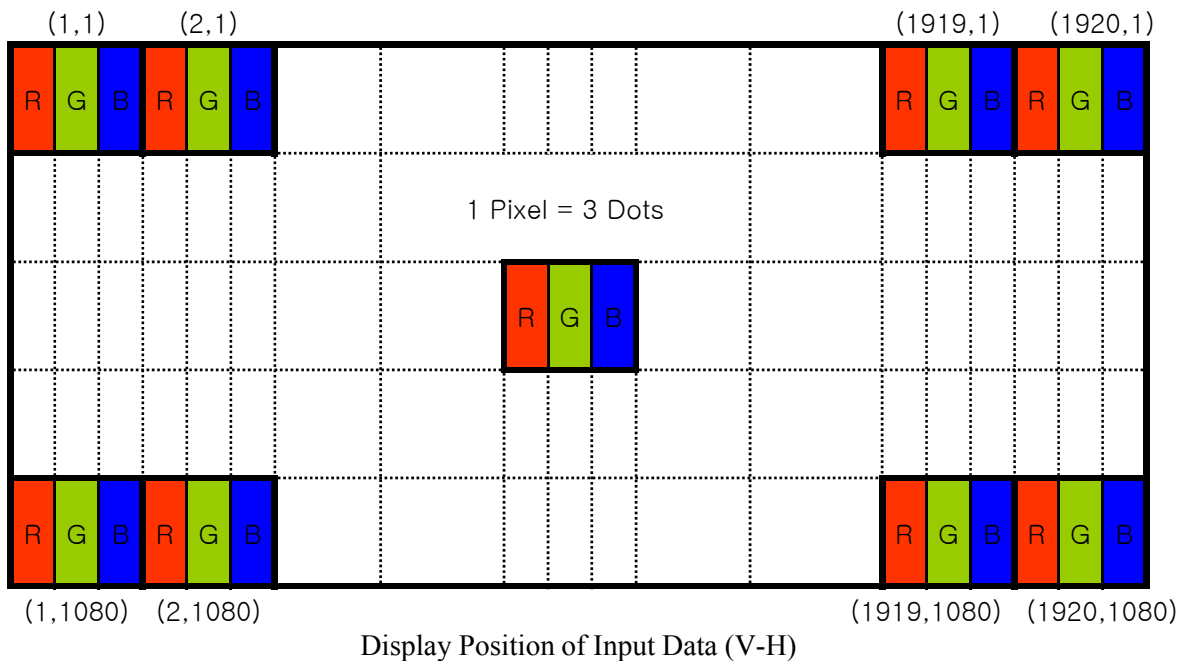

5.4 Back-light Interface Connection

● CN 2

LED LightBar Connector :CI1406M1HRL-NH or equivalent

Pin	Function
1	Channel 1 Current Feedback
2	Channel 2 Current Feedback
3	LED Power Supply
4	LED Power Supply
5	Channel3 Current Feedback
6	Channel4 Current Feedback

 京东方 BOE	PRODUCT GROUP	REV	ISSUE DATE
	PRODUCT SPEC-TFT MODULE	0	2012.03.05
SPEC. NUMBER	SPEC. TITLE		PAGE
	B3 HR215WU1-100 Product Specification_ Rev.0		14 OF 30

6.0 SIGNAL TIMING SPECIFICATION

6.1 The HR215WU1-100 is operated by the DE only.

Item		Symbols	Min	Typ	Max	Unit
Clock	Frequency	1/Tc	61.93	74.32	92.90	MHz
	High Time	Tch	-	4/7 Tc	-	
	Low Time	Tcl	-	3/7 Tc	-	
Frame Period		Tv	1091	1125	1149	lines
			50	60	75	Hz
			20	16.67	13.33	ms
Vertical Display Period		Tvd	-	1080	-	lines
One line Scanning Period		Th	1060	1100	1200	clocks
Horizontal Display Period		Thd	-	960	-	clocks



PRODUCT GROUP

REV

ISSUE DATE

PRODUCT SPEC-TFT MODULE

0

2012.03.05

SPEC. NUMBER

SPEC. TITLE

PAGE

B3 HR215WU1-100 Product Specification_ Rev.0

15 OF 30

6.2 LVDS Rx Interface Timing Parameter

The specification of the LVDS Rx interface timing parameter is shown in Table 4.

<Table 4. LVDS Rx Interface Timing Specification>

Item	Symbol	Min	Typ	Max	Unit	Remark
CLKIN Period	tRCIP	10.76	13.46	16.15	nsec	
Input Data 0	tRIP1	-0.4	0.0	+0.4	nsec	
Input Data 1	tRIP0	tRCIP/7-0.4	tRCIP/7	tRCIP/7+0.4	nsec	
Input Data 2	tRIP6	2 × tRCIP/7-0.4	2 × tRCIP/7	2 × tRCIP/7+0.4	nsec	
Input Data 3	tRIP5	3 × tRCIP/7-0.4	3 × tRCIP/7	3 × tRCIP/7+0.4	nsec	
Input Data 4	tRIP4	4 × tRCIP/7-0.4	4 × tRCIP/7	4 × tRCIP/7+0.4	nsec	
Input Data 5	tRIP3	5 × tRCIP/7-0.4	5 × tRCIP/7	5 × tRCIP/7+0.4	nsec	
Input Data 6	tRIP2	6 × tRCIP/7-0.4	6 × tRCIP/7	6 × tRCIP/7+0.4	nsec	

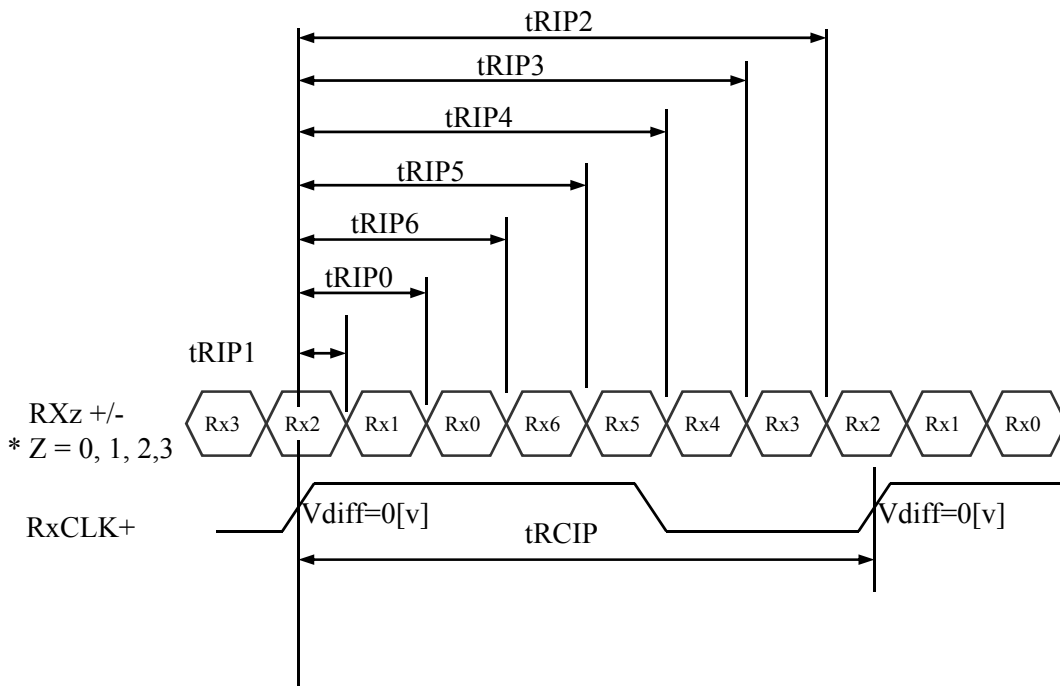

* Vdiff = (RXz+)-(RXz-),.... ,(RXCLK+)-(RXCLK-)



京东方
BOE

PRODUCT GROUP

REV

ISSUE DATE

PRODUCT SPEC-TFT MODULE

0

2012.03.05

SPEC. NUMBER

SPEC. TITLE

PAGE

B3 HR215WU1-100 Product Specification_ Rev.0

16 OF 30

7.0 SIGNAL TIMING WAVEFORMS OF INTERFACE SIGNAL

7.1 Sync Timing Waveforms

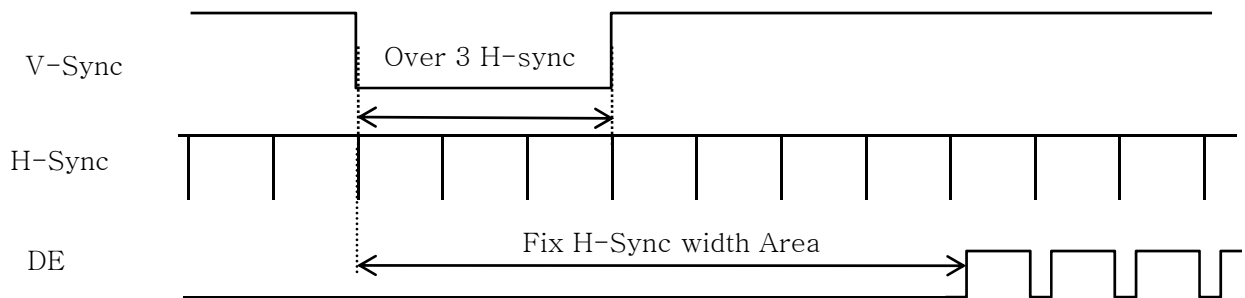

- 1) Need over 3 H-sync during V-Sync Low
- 2) Fix H-Sync width from V-Sync falling edge to first rising edge

7.2 Vertical Timing Waveforms

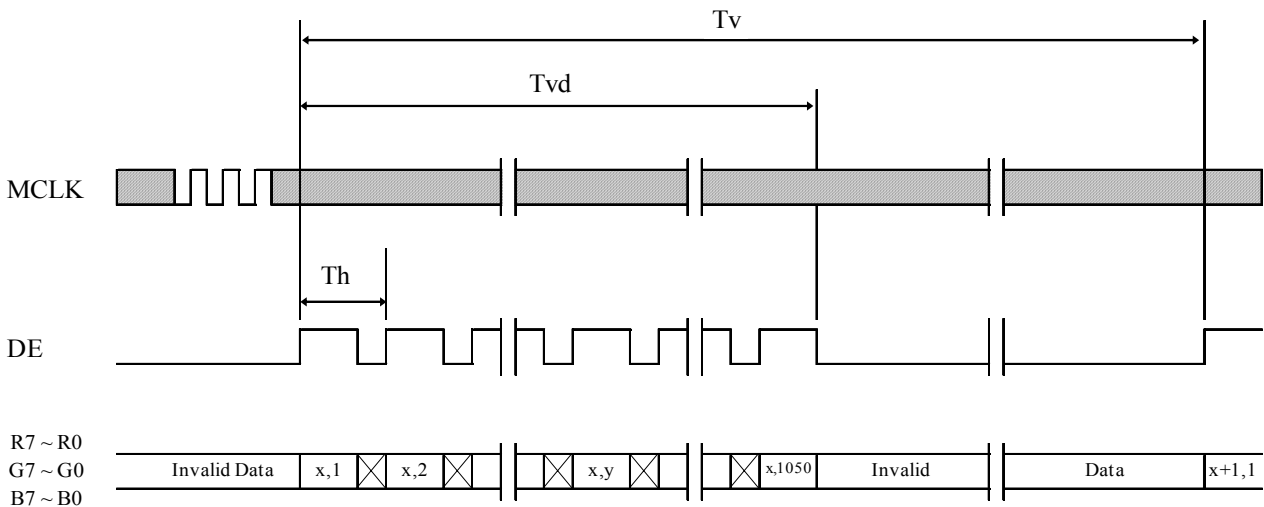



京东方
BOE

PRODUCT GROUP

REV

ISSUE DATE

PRODUCT SPEC-TFT MODULE

0

2012.03.05

SPEC. NUMBER

SPEC. TITLE

PAGE

B3 HR215WU1-100 Product Specification_ Rev.0

17 OF 30

7.3 Horizontal Timing Waveforms

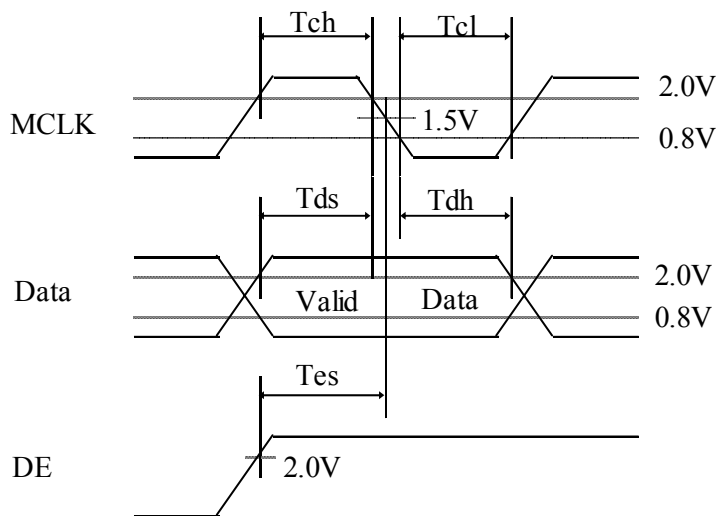
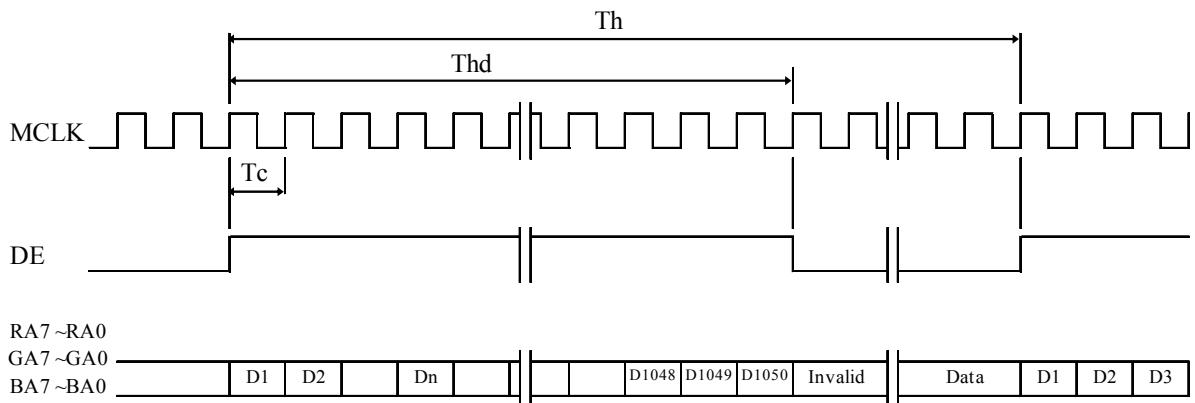



PRODUCT GROUP

REV

ISSUE DATE

PRODUCT SPEC-TFT MODULE

0

2012.03.05

SPEC. NUMBER

SPEC. TITLE

PAGE

B3 HR215WU1-100 Product Specification_ Rev.0

18 OF 30

8.0 INPUT SIGNALS, BASIC DISPLAY COLORS & GRAY SCALE OF COLORS

Color & Gray Scale		RED DATA								GREEN DATA								BLUE DATA							
		R7	R6	R5	R4	R3	R2	R1	R0	G7	G6	G5	G4	G3	G2	G1	G0	B7	B6	B5	B4	B3	B2	B1	B0
Basic Colors	Black	0	0	0	0	0	0	0	0	0	0	0	0	0	0	0	0	0	0	0	0	0	0	0	0
	Blue	0	0	0	0	0	0	0	0	0	0	0	0	0	0	0	0	1	1	1	1	1	1	1	1
	Green	0	0	0	0	0	0	0	0	1	1	1	1	1	1	1	1	0	0	0	0	0	0	0	0
	Cyan	0	0	0	0	0	0	0	0	1	1	1	1	1	1	1	1	1	1	1	1	1	1	1	1
	Red	1	1	1	1	1	1	1	1	0	0	0	0	0	0	0	0	0	0	0	0	0	0	0	0
	Magenta	1	1	1	1	1	1	1	1	0	0	0	0	0	0	0	0	1	1	1	1	1	1	1	1
	Yellow	1	1	1	1	1	1	1	1	1	1	1	1	1	1	1	1	0	0	0	0	0	0	0	0
	White	1	1	1	1	1	1	1	1	1	1	1	1	1	1	1	1	1	1	1	1	1	1	1	1
Gray Scale of RED	Black	0	0	0	0	0	0	0	0	0	0	0	0	0	0	0	0	0	0	0	0	0	0	0	0
	△	0	0	0	0	0	0	0	1	0	0	0	0	0	0	0	0	0	0	0	0	0	0	0	0
	Darker	0	0	0	0	0	0	1	0	0	0	0	0	0	0	0	0	0	0	0	0	0	0	0	0
	△	↑								↑								↑							
	▽	↓								↓								↓							
	Brighter	1	1	1	1	1	1	0	1	0	0	0	0	0	0	0	0	0	0	0	0	0	0	0	0
	▽	1	1	1	1	1	1	1	0	0	0	0	0	0	0	0	0	0	0	0	0	0	0	0	0
	Red	1	1	1	1	1	1	1	1	0	0	0	0	0	0	0	0	0	0	0	0	0	0	0	0
Gray Scale of GREEN	Black	0	0	0	0	0	0	0	0	0	0	0	0	0	0	0	0	0	0	0	0	0	0	0	0
	△	0	0	0	0	0	0	0	0	0	0	0	0	0	0	0	1	0	0	0	0	0	0	0	0
	Darker	0	0	0	0	0	0	0	0	0	0	0	0	0	0	1	0	0	0	0	0	0	0	0	0
	△	↑								↑								↑							
	▽	↓								↓								↓							
	Brighter	0	0	0	0	0	0	0	0	1	1	1	1	1	1	0	1	0	0	0	0	0	0	0	0
	▽	0	0	0	0	0	0	0	0	1	1	1	1	1	1	1	0	0	0	0	0	0	0	0	0
	Green	0	0	0	0	0	0	0	0	1	1	1	1	1	1	1	1	0	0	0	0	0	0	0	0
Gray Scale of BLUE	Black	0	0	0	0	0	0	0	0	0	0	0	0	0	0	0	0	0	0	0	0	0	0	0	0
	△	0	0	0	0	0	0	0	0	0	0	0	0	0	0	0	0	0	0	0	0	0	0	0	1
	Darker	0	0	0	0	0	0	0	0	0	0	0	0	0	0	0	0	0	0	0	0	0	0	0	1
	△	↑								↑								↑							
	▽	↓								↓								↓							
	Brighter	0	0	0	0	0	0	0	0	0	0	0	0	0	0	0	0	1	1	1	1	1	1	0	1
	▽	0	0	0	0	0	0	0	0	0	0	0	0	0	0	0	0	1	1	1	1	1	1	1	0
	Blue	0	0	0	0	0	0	0	0	0	0	0	0	0	0	0	0	1	1	1	1	1	1	1	1
Gray Scale of WHITE	Black	0	0	0	0	0	0	0	0	0	0	0	0	0	0	0	0	0	0	0	0	0	0	0	0
	△	0	0	0	0	0	0	0	1	0	0	0	0	0	0	0	1	0	0	0	0	0	0	0	1
	Darker	0	0	0	0	0	0	1	0	0	0	0	0	0	0	1	0	0	0	0	0	0	0	0	1
	△	↑								↑								↑							
	▽	↓								↓								↓							
	Brighter	1	1	1	1	1	1	0	1	1	1	1	1	1	1	0	1	1	1	1	1	1	1	0	1
	▽	1	1	1	1	1	1	1	0	1	1	1	1	1	1	1	0	1	1	1	1	1	1	1	0
	White	1	1	1	1	1	1	1	1	1	1	1	1	1	1	1	1	1	1	1	1	1	1	1	1

9.0 POWER SEQUENCE

To prevent a latch-up or DC operation of the LCD module, the power on/off sequence shall be as shown in below

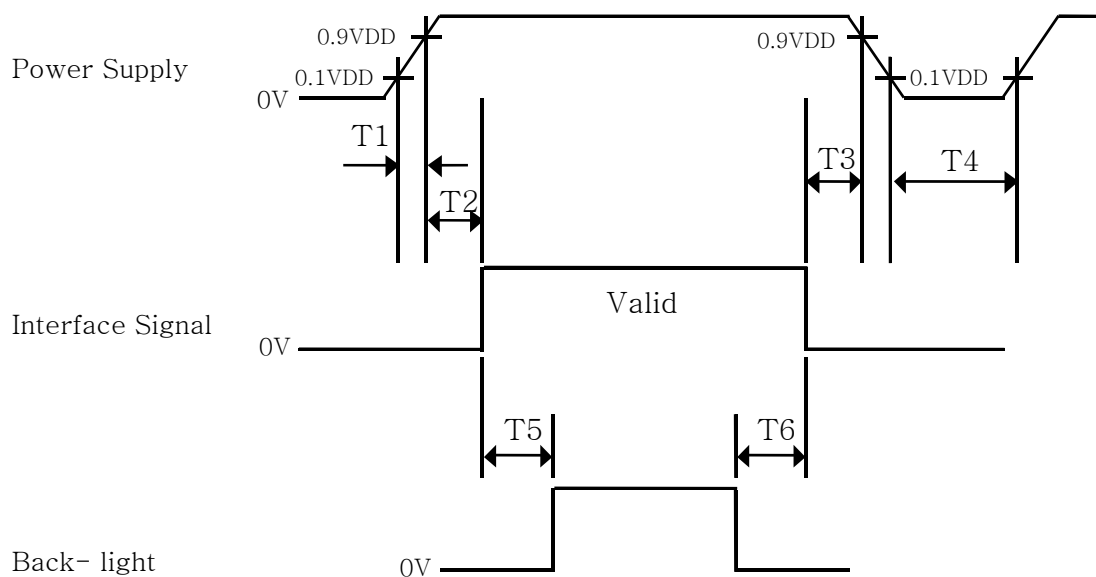

- $0.5 \text{ ms} \leq T1 \leq 10 \text{ ms}$
- $0 \leq T2 \leq 50 \text{ ms}$
- $0 \leq T3 \leq 50 \text{ ms}$
- $1 \text{ sec} \leq T4$
- $200 \text{ ms} \leq T5$
- $200 \text{ ms} \leq T6$

Notes:

1. When the power supply VDD is 0V, keep the level of input signals on the low or keep high impedance.
2. Do not keep the interface signal high impedance when power is on.
3. Back Light must be turn on after power for logic and interface signal are valid.

 京东方 BOE	PRODUCT GROUP	REV	ISSUE DATE
	PRODUCT SPEC-TFT MODULE	0	2012.03.05
SPEC. NUMBER	SPEC. TITLE B3 HR215WU1-100 Product Specification_ Rev.0		PAGE 20 OF 30

10.0 MECHANICAL CHARACTERISTICS

10.1 Dimensional Requirements

FIGURE 6 (located in Appendix) shows mechanical outlines for the model HR215WU1-100. Other parameters are shown in Table 5.

<Table 5. Dimensional Parameters>

Parameter	Specification	Unit
Dimensional outline	495.6 × 292.2 × 10.2	mm
Weight	1900(typ.)	gram
Active area	476.64(H) × 268.11(V)	mm
Pixel pitch	0.24825(H) x 0.24825(V)	mm
Number of pixels	1920(H) × 1080(V) (1 pixel = R + G + B dots)	pixels
Back-light	Lower side 1-LED Light bar Type	

10.2 Mounting

See FIGURE 5. (shown in Appendix)

10.3 Semi-Glare and Polarizer Hardness.

The surface of the LCD has an Anti-glare coating to reduce reflection and a coating to reduce scratching.

10.4 Light Leakage

There shall not be visible light from the back-lighting system around the edges of the screen as seen from a distance 50cm from the screen with an overhead light level of 250lux.



京东方
BOE

PRODUCT GROUP

REV

ISSUE DATE

PRODUCT SPEC-TFT MODULE

0

2012.03.05

SPEC. NUMBER

SPEC. TITLE

PAGE

B3 HR215WU1-100 Product Specification_ Rev.0

21 OF 30

11.0 RELIABILITY TEST

The Reliability test items and its conditions are shown in below.

<Table 6. Reliability Test Parameters >

No	Test Items	Conditions	
1	High temperature storage test	Ta = 60 °C, 240 hrs	
2	Low temperature storage test	Ta = -20 °C, 240 hrs	
3	High temperature & high humidity operation test	Ta = 50 °C, 80%RH, 240hrs	
4	High temperature operation test	Ta = 50 °C, 240hrs	
5	Low temperature operation test	Ta = 0 °C, 240hrs	
6	Thermal shock	Ta = -20 °C ↔ 60 °C (0.5 hr), 100 cycle	
7	Vibration test (non-operating)	Frequency	10 ~ 300 Hz, Sweep rate 30 min
		Gravity / AMP	1.5 G
		Period	X, Y, Z 30 min
8	Shock test (non-operating)	Gravity	50G
		Pulse width	11msec, sine wave
		Direction	± X, ± Y, ± Z Once for each
9	Electro-static discharge test (non-operating)	Air	: 150 pF, 330Ω, 15 KV
		Contact	: 150 pF, 330Ω, 8 KV
10	Altitude test	Operating: 0 to 16400ft , 0 to 40°	
		Non Operating: 0 to 40000ft, -20 to 40°	

 京东方 BOE	PRODUCT GROUP	REV	ISSUE DATE
	PRODUCT SPEC-TFT MODULE	0	2012.03.05
SPEC. NUMBER	SPEC. TITLE		PAGE
	B3 HR215WU1-100 Product Specification_ Rev.0		22 OF 30

12.0 HANDLING & CAUTIONS

- (1) Cautions when taking out the module
 - Pick the pouch only, when taking out module from a shipping package.
- (2) Cautions for handling the module
 - As the electrostatic discharges may break the LCD module, handle the LCD module with care. Peel a protection sheet off from the LCD panel surface as slowly as possible.
 - As the LCD panel and back - light element are made from fragile glass material, impulse and pressure to the LCD module should be avoided.
 - As the surface of the polarizer is very soft and easily scratched, use a soft dry cloth without chemicals for cleaning.
 - Do not pull the interface connector in or out while the LCD module is operating.
 - Put the module display side down on a flat horizontal plane.
 - Handle connectors and cables with care.
- (3) Cautions for the operation
 - When the module is operating, do not lose CLK, ENAB signals. If any one of these signals is lost, the LCD panel would be damaged.
 - Obey the supply voltage sequence. If wrong sequence is applied, the module would be damaged.
- (4) Cautions for the atmosphere
 - Dew drop atmosphere should be avoided.
 - Do not store and/or operate the LCD module in a high temperature and/or humidity atmosphere. Storage in an electro-conductive polymer packing pouch and under relatively low temperature atmosphere is recommended.
- (5) Cautions for the module characteristics
 - Do not apply fixed pattern data signal to the LCD module at product aging.
 - Applying fixed pattern for a long time may cause image sticking.
- (6) Other cautions
 - Do not disassemble and/or re-assemble LCD module.
 - Do not re-adjust variable resistor or switch etc.
 - When returning the module for repair or etc., Please pack the module not to be broken. We recommend to use the original shipping packages.

 京东方 BOE	PRODUCT GROUP	REV	ISSUE DATE
	PRODUCT SPEC-TFT MODULE	0	2012.03.05
SPEC. NUMBER	SPEC. TITLE		PAGE
	B3 HR215WU1-100 Product Specification_ Rev.0		23 OF 30

13.0 PRODUCT SERIAL NUMBER

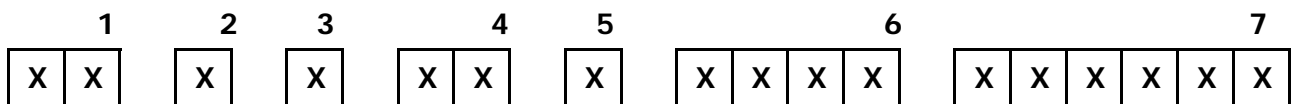

- 1. Control Number
- 2. Rank / Grade
- 3. Line Classification
- 4. Year (2001 : 01, 2002 : 02, ...)

- 5. Month (1,2,3, ... , 9, X, Y, Z)
- 6. Internal Use
- 7. Serial Number

 京东方 BOE	PRODUCT GROUP	REV	ISSUE DATE
	PRODUCT SPEC-TFT MODULE	0	2012.03.05
SPEC. NUMBER	SPEC. TITLE		PAGE
	B3 HR215WU1-100 Product Specification_ Rev.0		24 OF 30

14.0 Packing

14.1 Packing Order

Put EPE Cushion into the box

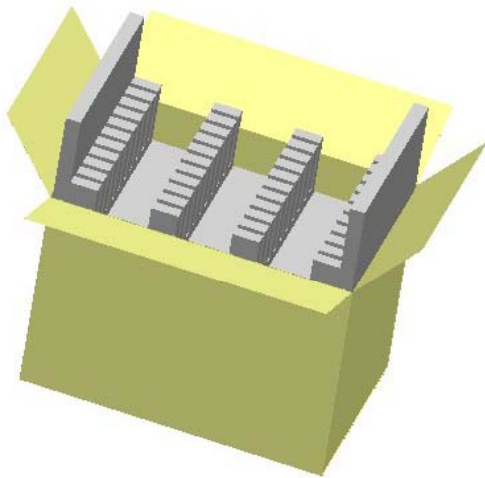

As shown in the figure, place the modules bundled by packing bag In the box

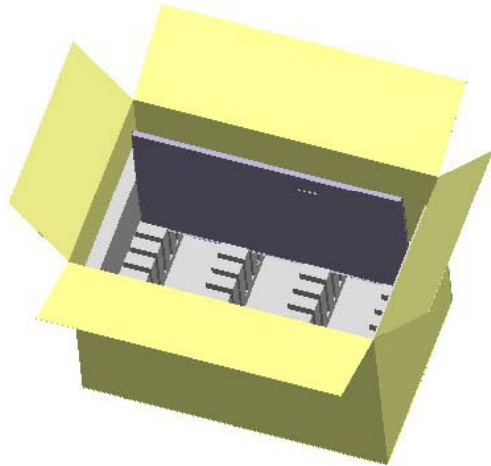

After sealing the box, attach Packing Label on the attach position sign area of the box.

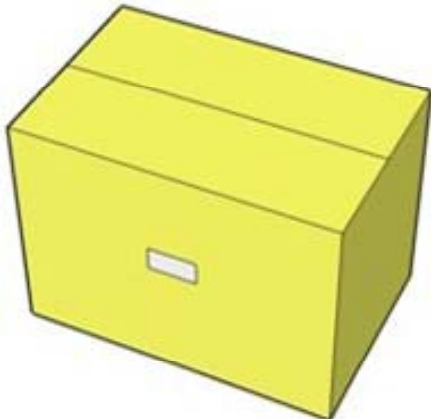

Place EPE cover on top of the box

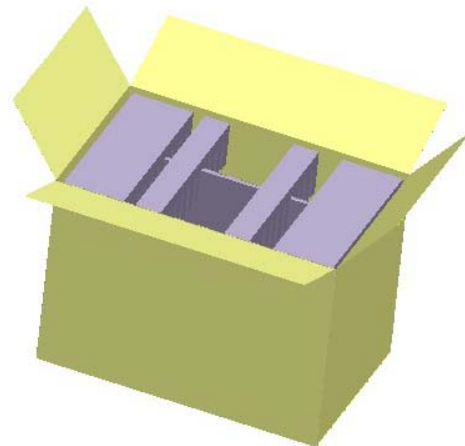

 京东方 BOE	PRODUCT GROUP	REV	ISSUE DATE
	PRODUCT SPEC-TFT MODULE	0	2012.03.05
SPEC. NUMBER	SPEC. TITLE		PAGE
	B3 HR215WU1-100 Product Specification_ Rev.0		25 OF 30

14.2 Pallet Packing Order

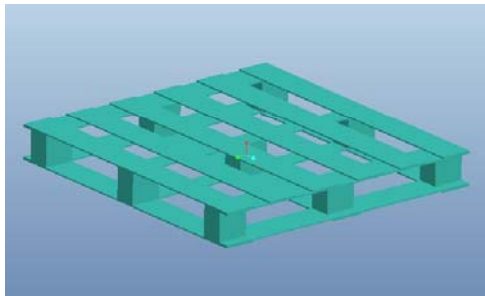

Load Pallet in correct position

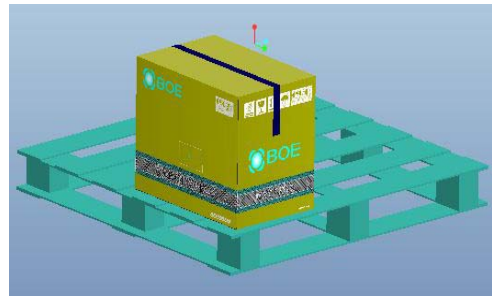

Pile up the unit Box filled with Modules on the Pallet carefully not to make a space.

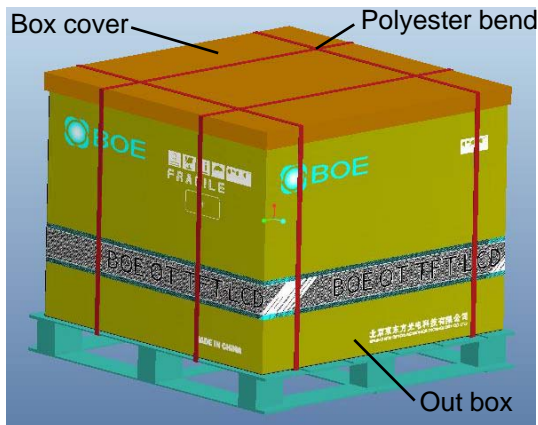

Adjust Outer box to piling Boxes and cover the Outer box using box cover. Bend Pallet Assy which is putting the Box Cover tight in two direction (horizontal and vertical) and two times using Polyester bend.

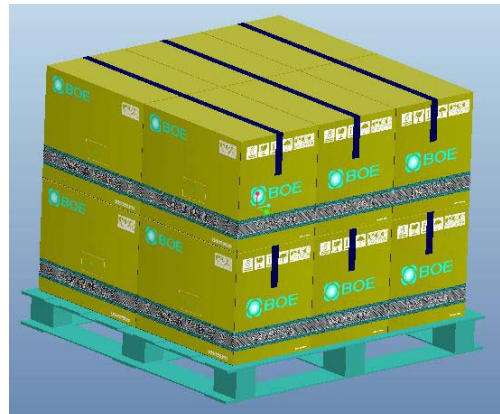

Wrap the Pallet Assy loaded 1story, 2stories from downside through side and to edge of upside. (12Boxes/Pallet)



 京东方 BOE	PRODUCT GROUP	REV	ISSUE DATE
	PRODUCT SPEC-TFT MODULE	0	2012.03.05
SPEC. NUMBER	SPEC. TITLE		PAGE
	B3 HR215WU1-100 Product Specification_ Rev.0		26 OF 30

14.3 Packing Specification and Note

Item	Specification			Remark
	Q'ty	Dimension	Weight (kg)	
Panel	1	495.6(H) × 292.2(V) × 10.2(D) typ.	1.9	-
Cushion	1	-	0.70	-
Box	1	558(L)mm x 348(W)mm x 400(H)mm	0.70	without Panel & cushion
Packing Box	10pcs/Box	558(L)mm x 348(W)mm x 400(H)mm	20.4	with panel & cushion
Pallet	1	1200(L)mm x 1140(W)mm x 120(H)mm	15.90	-
Pallet after Packing	12boxes/pallet	1140(L)mm x 1076(W)mm x 820(H)mm	264	-

14.3 Box label

- Label Size : 108 mm (L) × 56 mm (W)
- Contents
 - Model : HR215WU1-100
 - Q'ty : Module Q'ty in one box
 - Serial No. : Box Serial No. See next page for detail description.
 - Date : Packing Date
 - FG Code : FG Code of Product

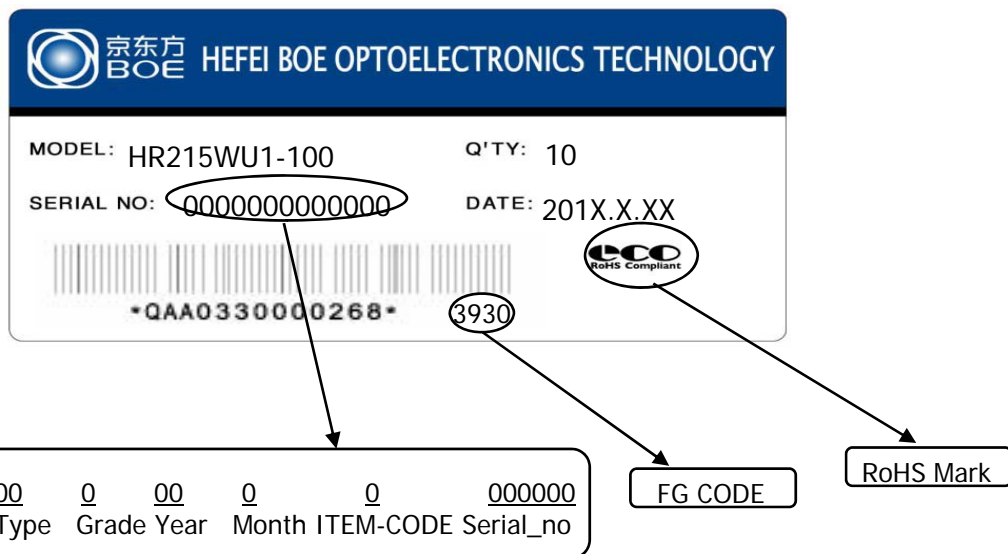

MODEL: HR215WU1-100 Q'TY: 10
 SERIAL NO: 00000000000000 DATE: 201X.X.XX
 QAA0330000268 3930 RoHS Compliant

00	0	00	0	0	000000
Type	Grade	Year	Month	ITEM-CODE	Serial_no

FG CODE RoHS Mark

 京东方 BOE	PRODUCT GROUP	REV	ISSUE DATE
	PRODUCT SPEC-TFT MODULE	0	2012.03.05
SPEC. NUMBER	SPEC. TITLE		PAGE
	B3 HR215WU1-100 Product Specification_ Rev.0		27 OF 30

15.0 APPENDIX

Figure 1. Measurement Set Up

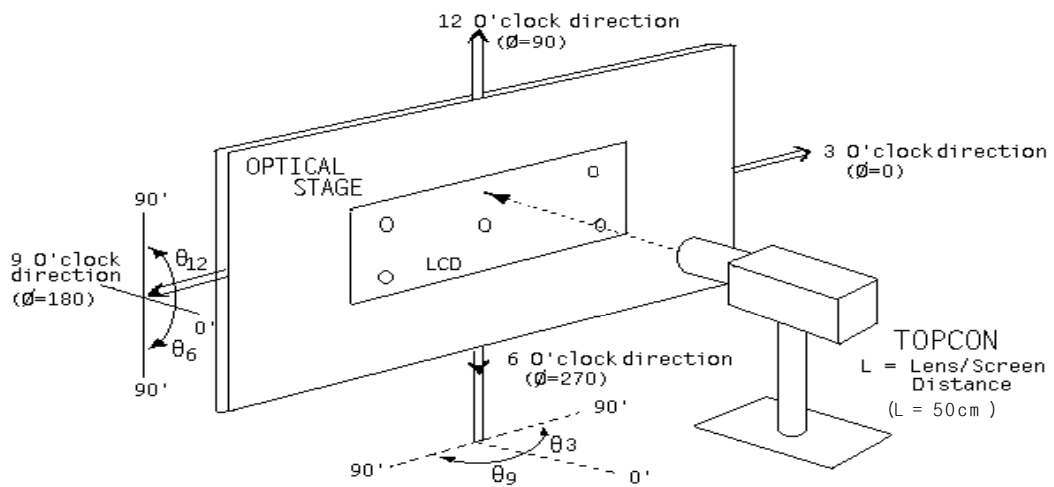

Figure 2. White Luminance and Uniformity Measurement Locations (9 points)

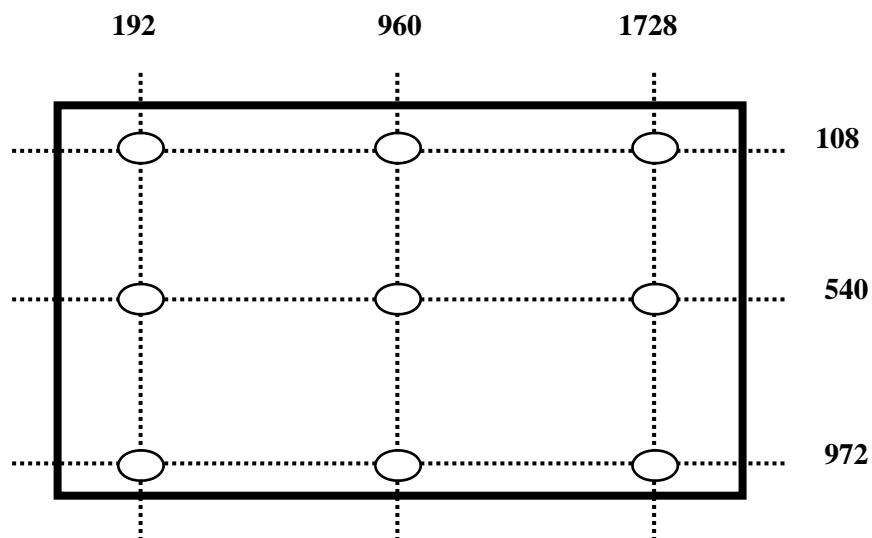
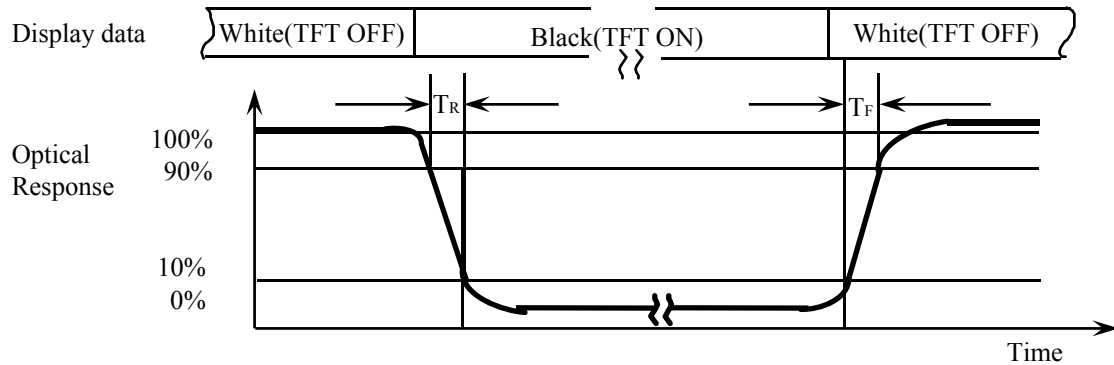
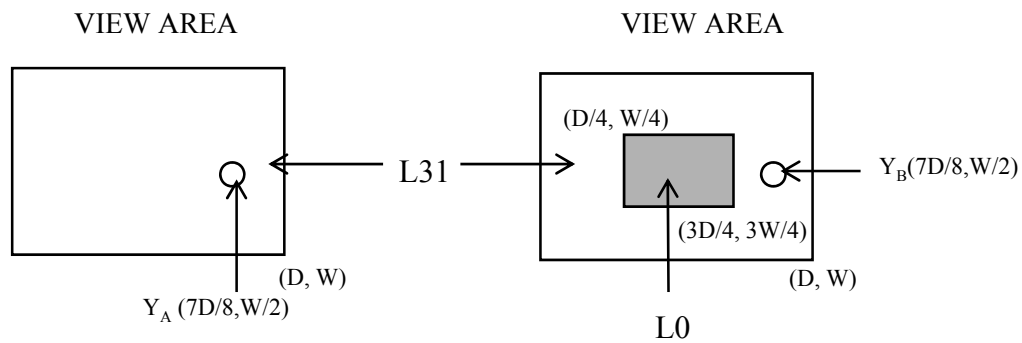

Figure 3. Response Time Testing

Figure 4. Cross Modulation Test Description

$$\text{Cross-Talk (\%)} = \left| \frac{Y_B - Y_A}{Y_A} \right| \times 100$$

Where: Y_A = Initial luminance of measured area (cd/m^2)

Y_B = Subsequent luminance of measured area (cd/m^2)

The location measured will be exactly the same in both patterns



京东方
BOE

PRODUCT GROUP

REV

ISSUE DATE

PRODUCT SPEC-TFT MODULE

0

2012.03.05

SPEC. NUMBER

SPEC. TITLE

PAGE

B3 HR215WU1-100 Product Specification_ Rev.0

30 OF 30

Figure 6. TFT-LCD Module Outline Dimensions (Rear view)

